

PHILIPS

Lighting

Tailored creations



Pendants

PD Series

A classic PAR38 cylinder refreshed with new surface textures and finish options



PAR38 Cylinders PD Series



Gorgeous new finishes

Intricate new finishes add a decorative flourish to a classic geometric shape

Digital manufacturing techniques create new surface textures resembling machine-turned, woven, or deeply etched finish styles

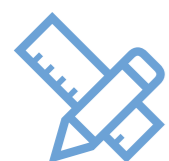

Tailored to your preference

Custom designs for demanding project needs

With our flexible digital production system, our fixtures can be modified in a variety of ways. Contact us to discuss your specific needs.



Fast lead times

Custom options delivered fast

We can supply a wide range of customization options without long lead times. Our revolutionary new manufacturing technology allows us to deliver unprecedented speed, flexibility and economy.

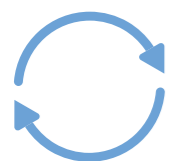

Circular economy ready

Fixtures inherently designed for low environmental impact

We optimize the design of our fixtures expressly to reduce our product's environmental impact: Lightweight materials reduce our carbon footprint during production and reduce the fixture's weight to minimize our transportation footprint.

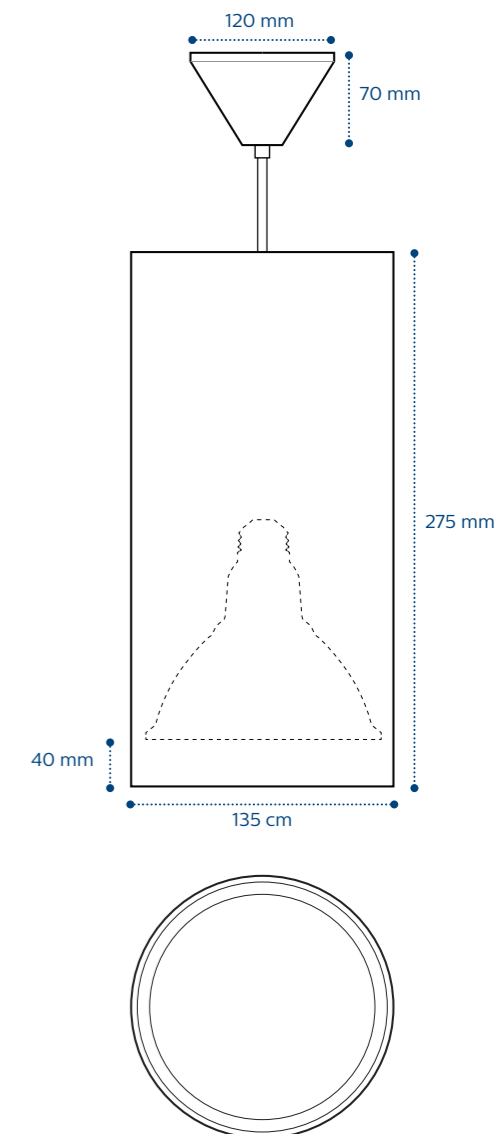

A classic lamp format refreshed

Ensure ease of long-term maintenance with the timeless industry standard E-27 socket. And with the newest Philips PAR38 LED lamps, select from options including up to 1300 lumen output, CRI 90 and classic glass housings.



Finish options

Select from 9 color and texture combinations

**Layered Coarse
T101A**



**Deep Groove
T301A**



**Woven Oval
T302A**

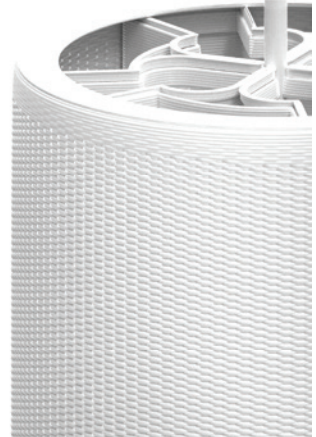

**Glossy White
WH200A**

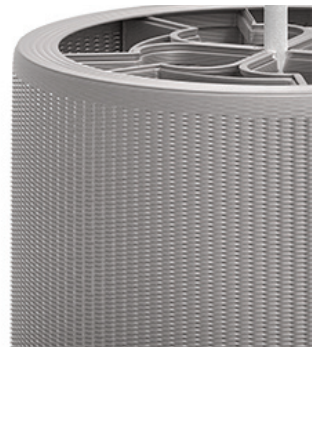
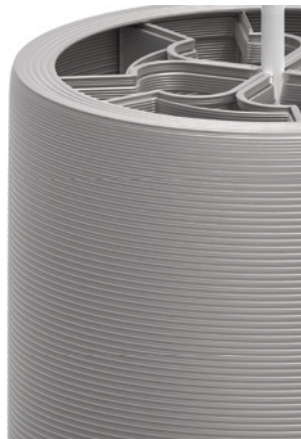
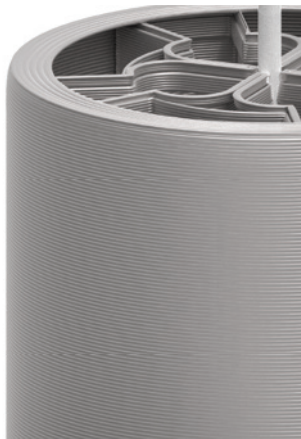

**Silver
SI200A**

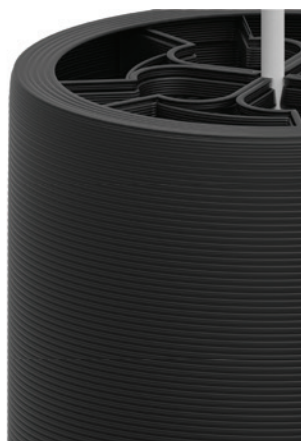

**Matte Black
BK600A**